

Varenummer: 0118021
 Beskrivelse: Seeger låsering H 8

Mål

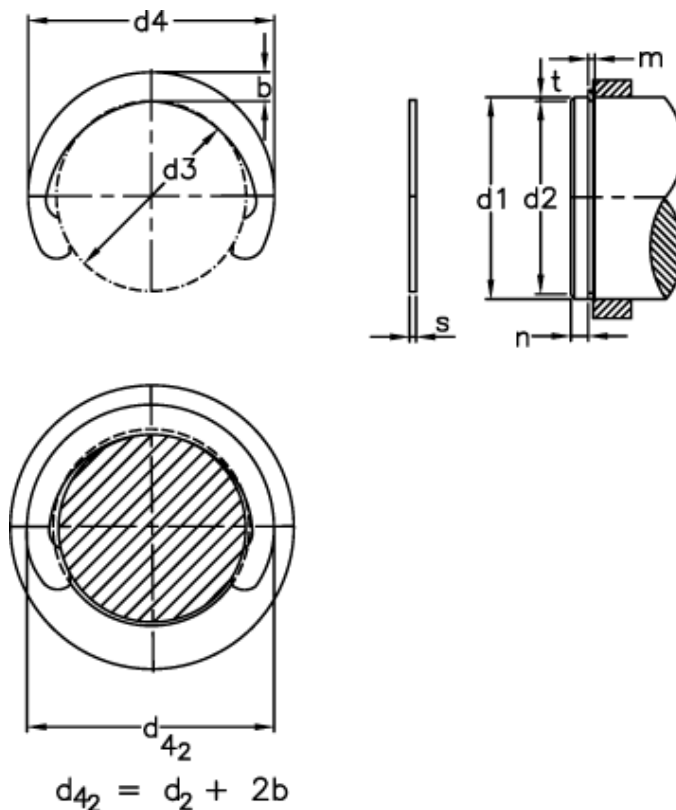

b	= 1.60	FRg kN	= 1.3	t	= 0.50
Betegnelse	= H 8,0	FR kN	= 2.20	tol	= -0.09
d1	= 8	g	= 0.80	tol	= 0.09
d2	= 7.0	Griber	= GRH 8	tol	= -0.05
d3	= 6.80	m min	= 0.85	vægt kg/1000	= 0.17
d4	= 10.00	n abl x 1000	= 67		
d4 2	= 10.2	Nominel træk	= 1.5		
FN kN	= 0.98	s	= 0.80		